

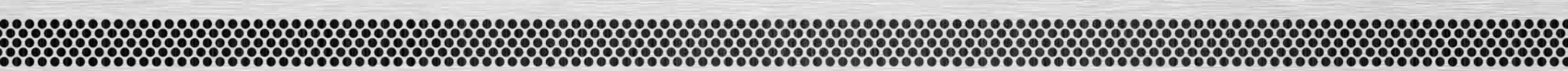

Hendrick
ARCHITECTURAL



MANUFACTURER OF PERFORATED METAL PRODUCTS, PROFILE BAR & WEDGE WIRE GRILLES

Rare Aesthetics

Environmentally
Responsible Materials

Dynamic Performance
& Energy Efficiency

Low Maintenance



H-CLAD

Hendrick's H-CLAD™ is a standardized cladding and mounting system that has been tested and proven to offer practical and functional benefits.

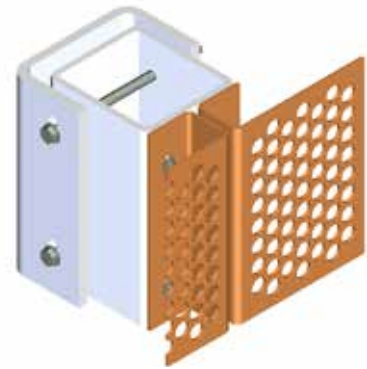

H-CLAD HD

Ideal for...

- Parking Garages
- Larger Cantilevers
- Larger spans between mounting brackets

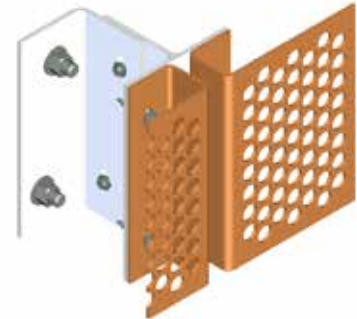

H-CLAD MD

- Office buildings and over windows
- Minimal Cantilevers
- Medium spans between mounting brackets
- Back lighting friendly
- Slim design

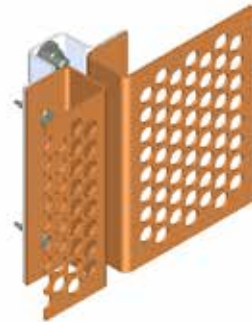

H-CLAD LD

- Interior or solid wall applications
- No cantilevers
- Minimal spans between mounting
- Minimal offset from the building

- Aluminum panel thickness of .125" or .190"
- Standard panel widths of 36", 42" or 48"
- Standard panel lengths of 72", 96" or 120"
- 12 standard round perforated patterns with open areas ranging from 23% to 77%
- Designed to withstand sustained winds up to 165 mph (Category 5)
- Multiple finish options offered to ensure the highest quality finish for your project
- Finish warranty options are available up to 20 years
- Concealed fastener panel system design
- All hardware supplied is solid stainless steel

Standard 60° staggered Patterns

- .250" dia. x .500" (23% open area)
- .375" dia. x .625" (33% open area)
- .375" dia. x .750" (23% open area)
- .500" dia. x .750" (40% open area)
- .500" dia. x 1.000" (23% open area)
- .750" dia. x 1.000" (51% open area)
- .750" dia. x 1.250" (33% open area)
- 1.000" dia. x 1.250" (58% open area)
- 1.000" dia. x 2.000" (23% open area)
- 1.500" dia. x 1.750" (67% open area)
- 2.000" dia. x 2.250" (72% open area)
- 3.000" dia. x 3.250" (72% open area)

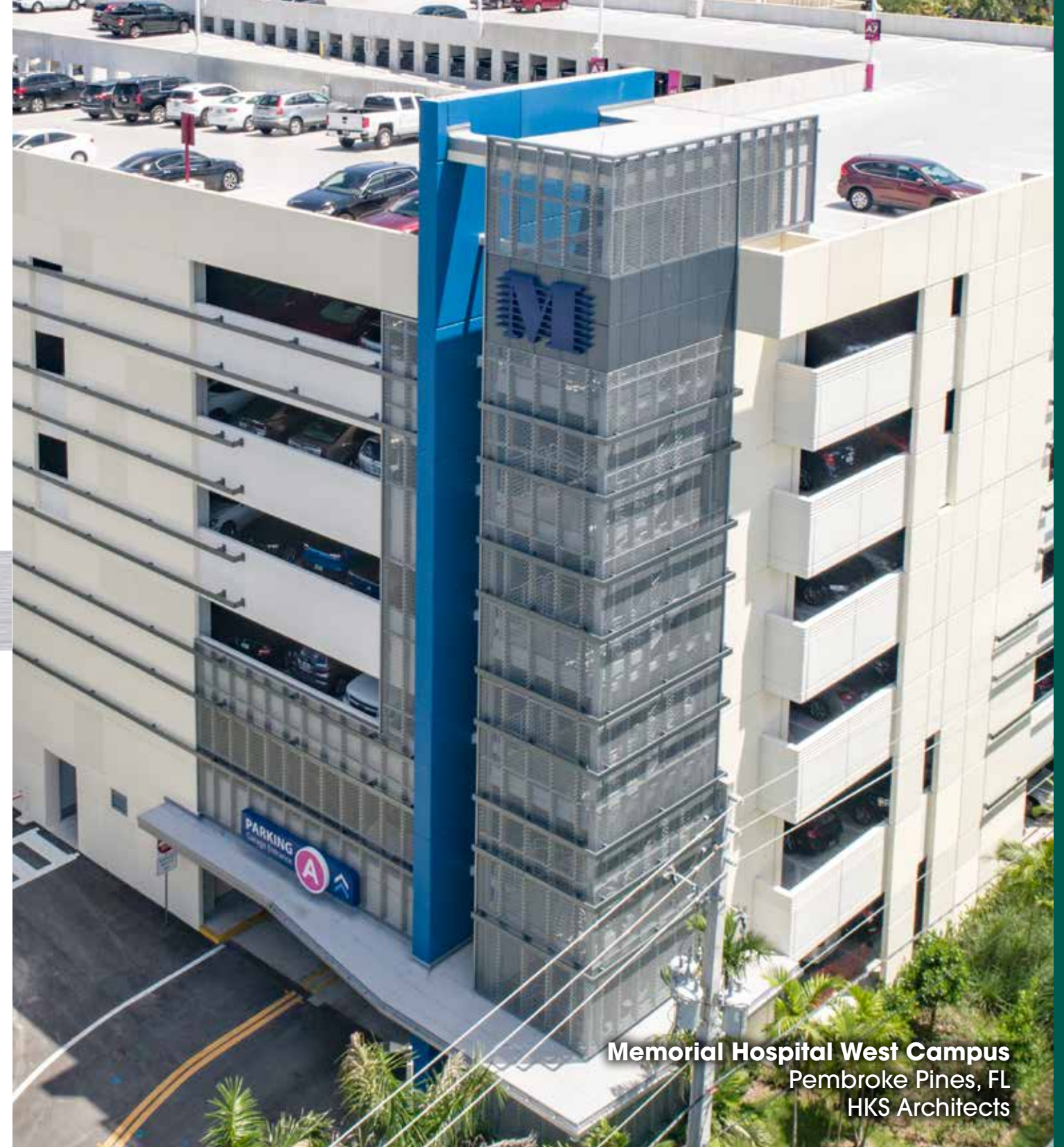

Memorial Hospital West Campus
Pembroke Pines, FL
HKS Architects

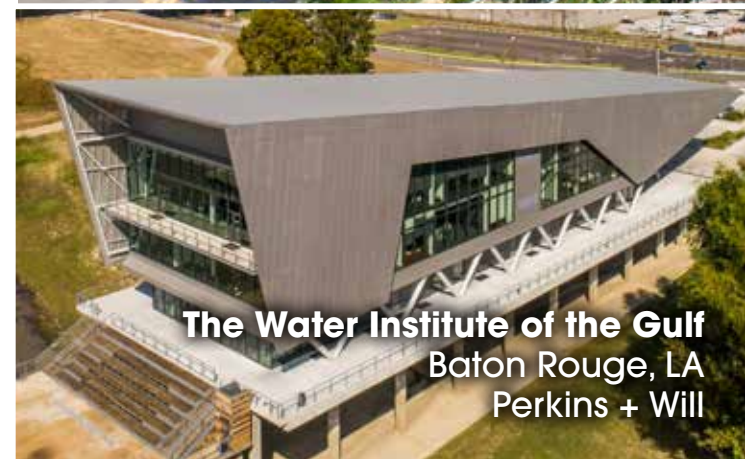

The Water Institute of the Gulf
Baton Rouge, LA
Perkins + Will



Route 9 Library & Innovation Center
New Castle, DE
Perkins + Will

H-CLAD

**CLINIC
MEDICINE**

MAYO

Mayo Clinic Sports Medicine

Minneapolis, MN

RSP Architects

perforated imaging
custom perforation
aluminum



The IMAGE-CLAD™ process begins with your graphic, image, logo, photo, or text. Our software then converts it into a perforated pattern by varying the size, spacing, and density of the holes. Lastly, our team of expert designers refine the output model to maximize the clarity of the input graphic, image, logo, photo, or text. Hendrick is licensed and authorized under the "688 Patent" to manufacture and sell perforated image panels.



Good Hope Recreation Center

Silver Spring, MD

DLR Group

perforated imaging
custom perforation
aluminum

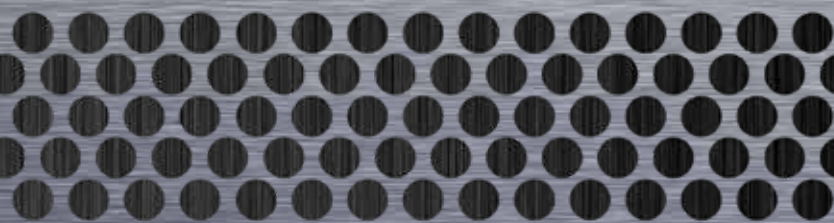
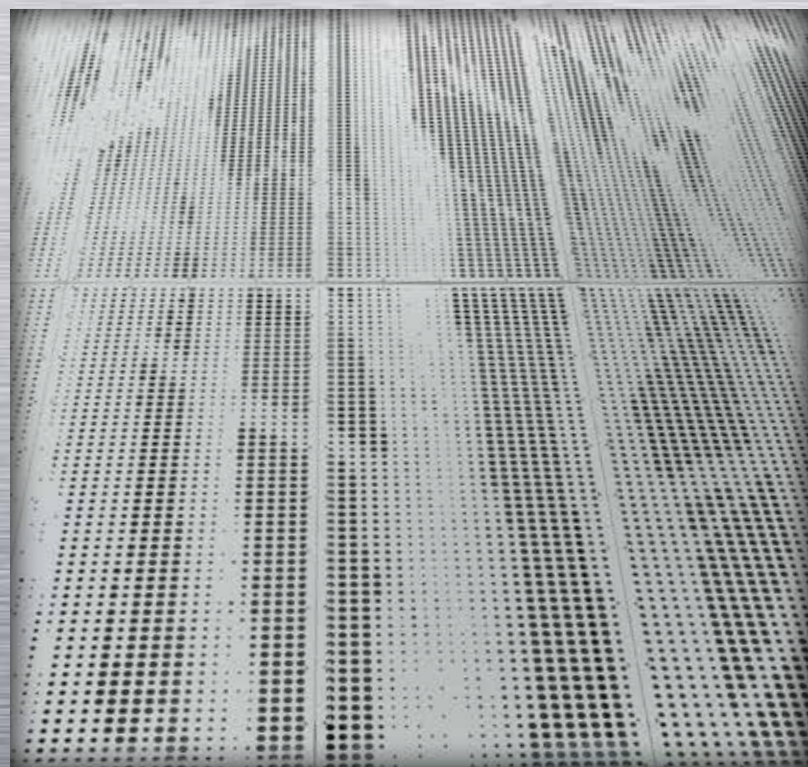

The IMAGE-CLAD™ process begins with your graphic, image, logo, photo, or text. Our software then converts it into a perforated pattern by varying the size, spacing, and density of the holes. Lastly, our team of expert designers refine the output model to maximize the clarity of the input graphic, image, logo, photo, or text. Hendrick is licensed and authorized under the "688 Patent" to manufacture and sell perforated image panels.



Xilinx

San Jose, CA

Noll & Tam Architects

custom laser cut façade

36% open area

aluminum

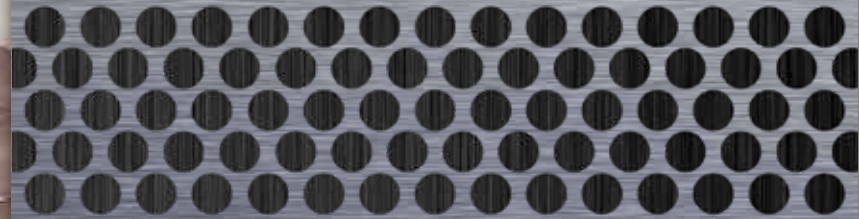

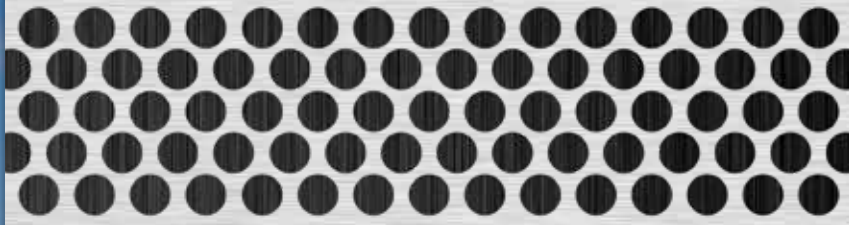

The Lakes at Techridge

Pflugerville, TX

STG Design

custom laser cut panels

56% open area

aluminum

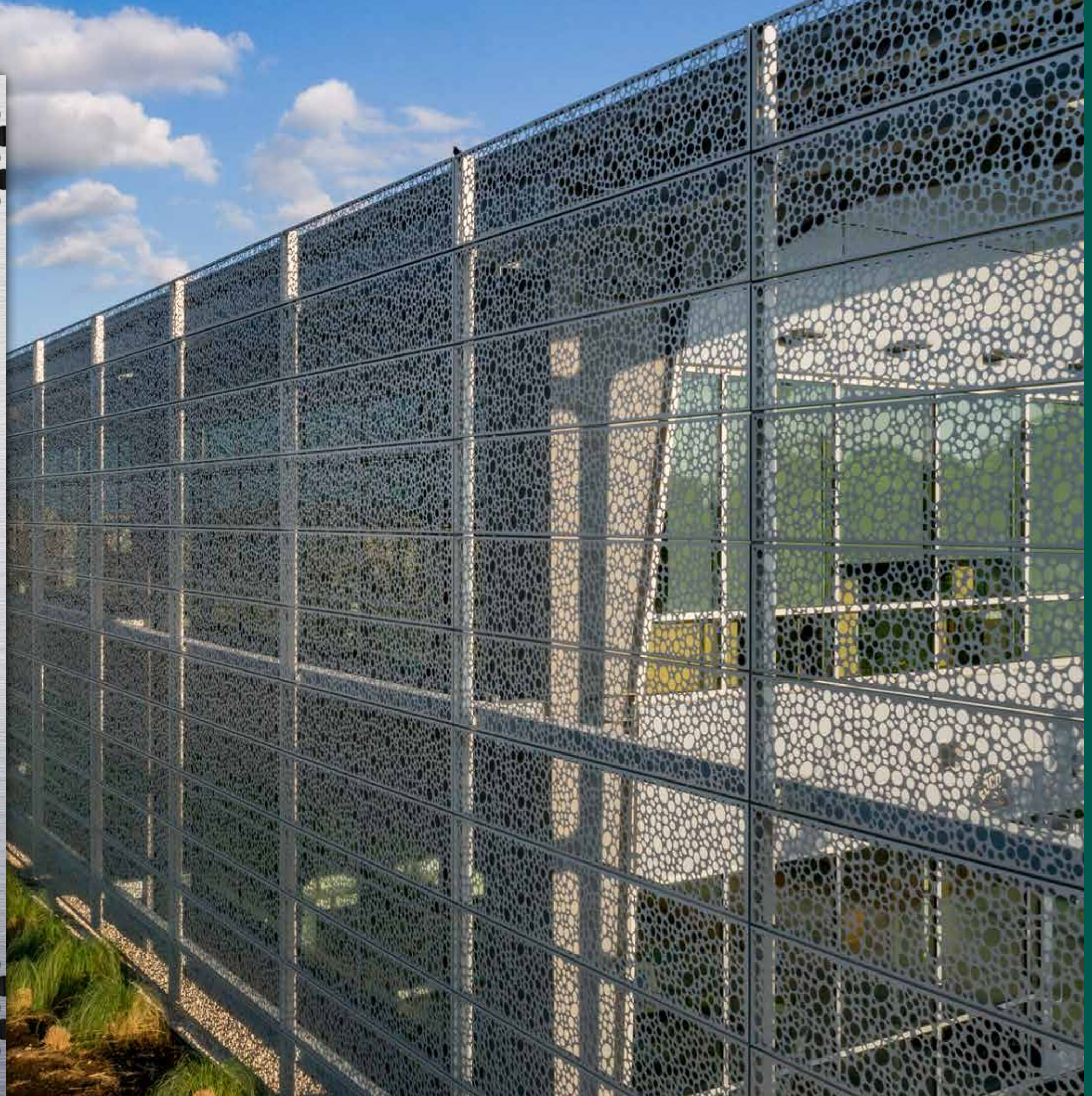
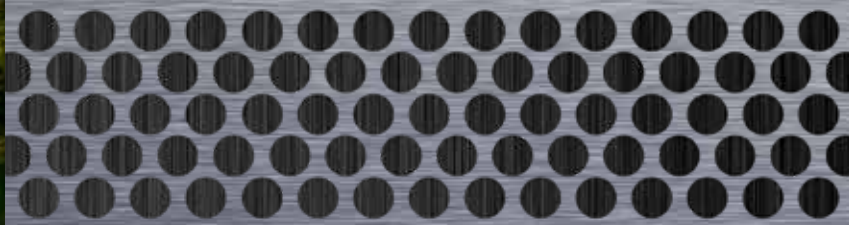

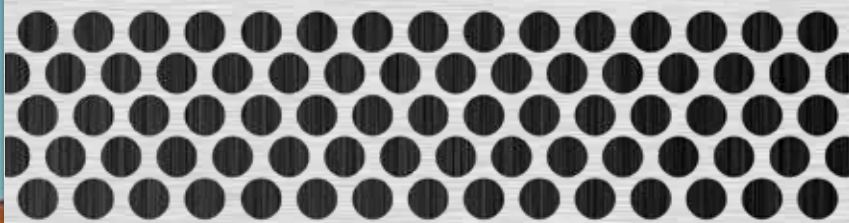

CUSTOM LASER CUTTING

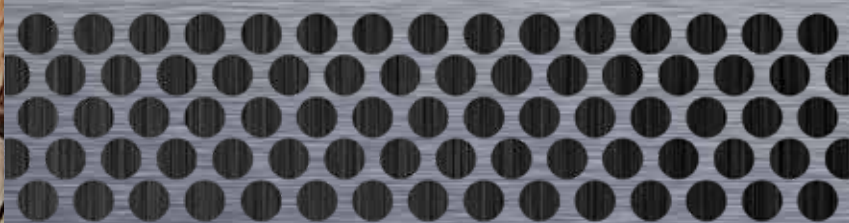

The Melting Pot
Oklahoma City, OK
A.D.G.

perforated cladding
.375" dia. holes | 33% open area
weathered steel



PERFORATED WEATHERED STEEL CLADDING

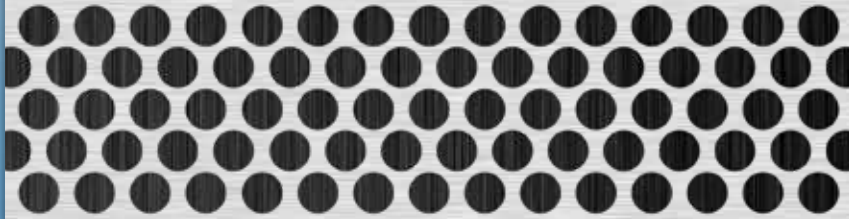

**University of Florida Health
Proton Therapy Institute**

Jacksonville, FL

Tsoi/Kobus & Associates

perforated sunshades
.313" dia. holes | 36% open area
aluminum

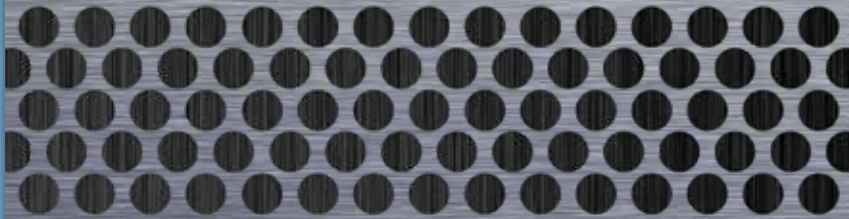

PERFORATED SUNSHADES

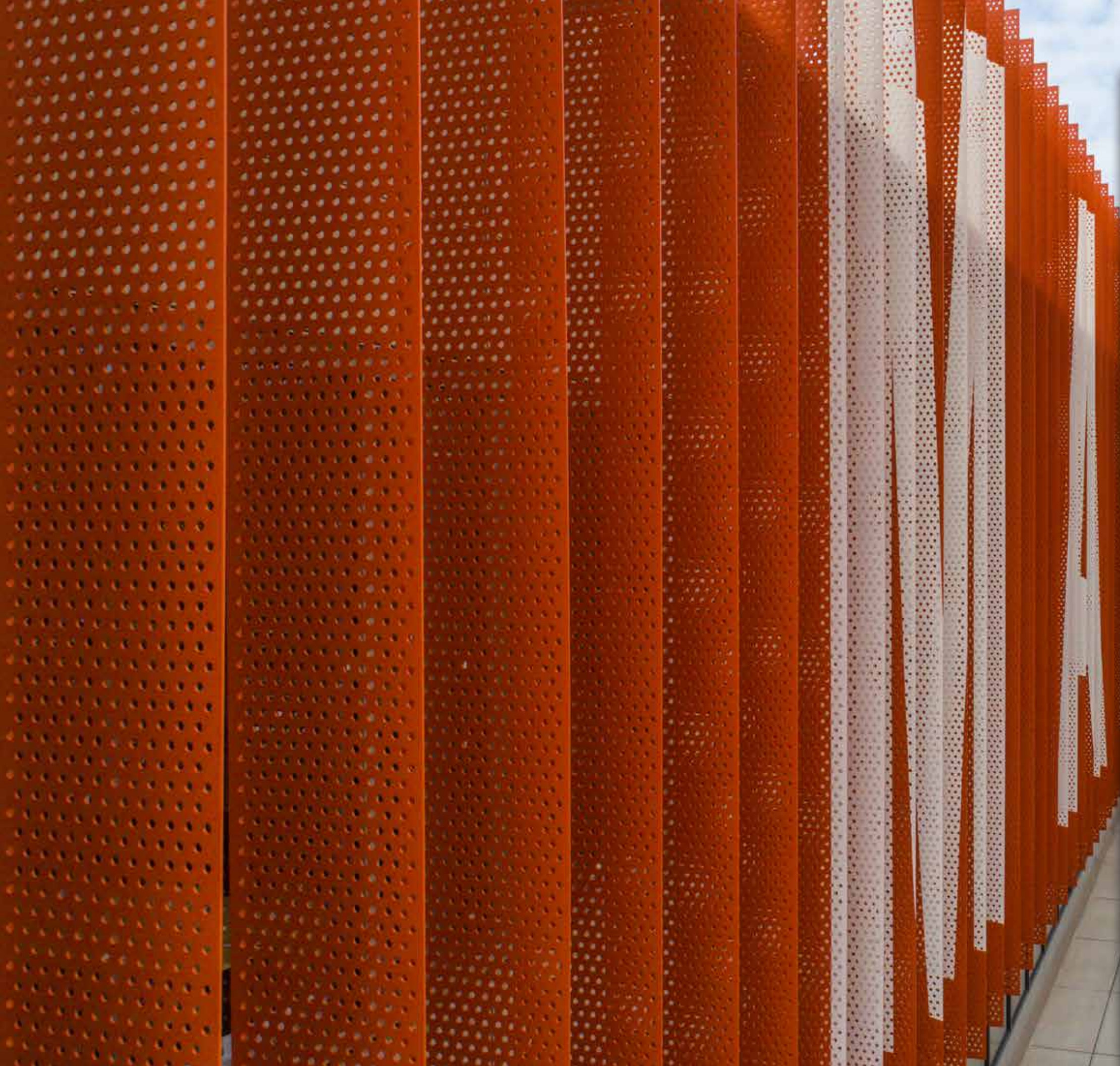

Ponce City Market
Atlanta, GA
S9 Architecture

perforated sunshades
.625" dia. holes | 18% open area
aluminum



Standard Perforated Patterns

An endless choice of perforated patterns are available, in a variety of shapes, sizes, and materials. The following is a selection of Hendrick's popular patterns.

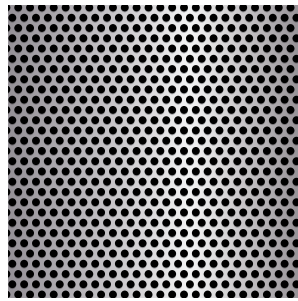

.125" dia. x .188"
staggered
40% open area

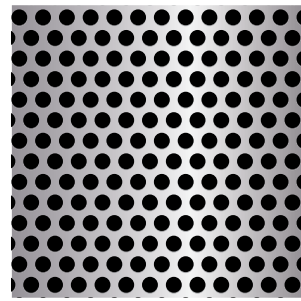

.250" dia. x .375"
staggered
40% open area

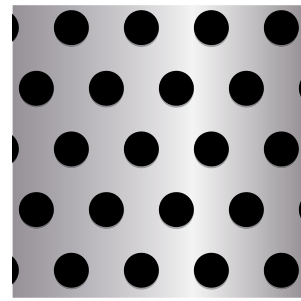

.500" dia. x 1.000"
staggered
23% open area

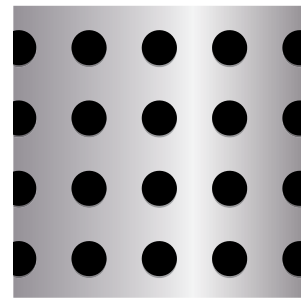

.500" dia. x 1.000"
straight
20% open area

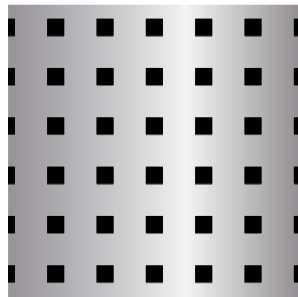

.250" sqr. x .750"
straight
11% open area

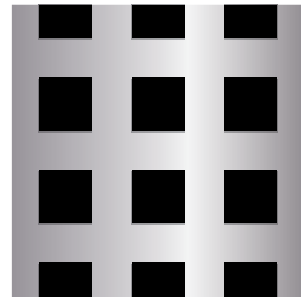

.750" sqr. x 1.313"
straight
33% open area

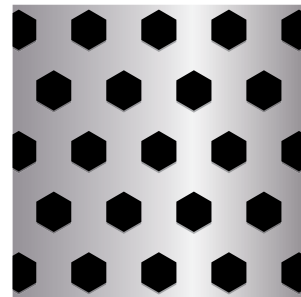

.500" hex. x 1.000"
staggered
25% open area

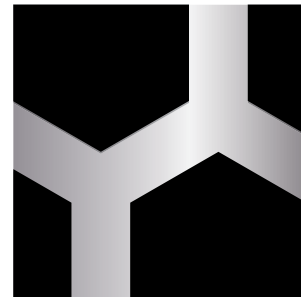

2.598" hex. x 3.464"
staggered
56% open area

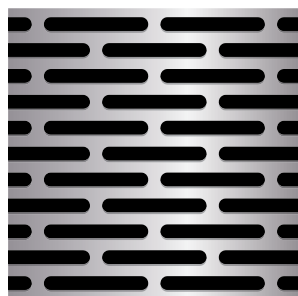

.188" x 1.500"
obround on .375"
staggered
43% open area

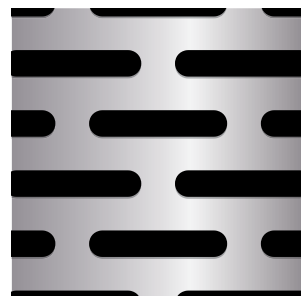

.375" x 2.000"
obround on .875"
staggered
33% open area

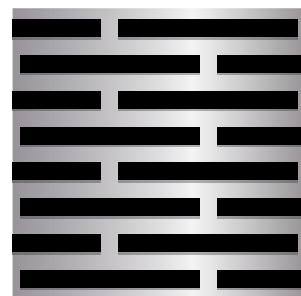

.250" x 2.500 rec.
on .500"
staggered
45% open area

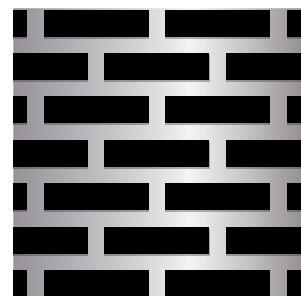

.375" x 1.500" rec.
on .625"
staggered
51% open area

Designer Series Perforated Patterns

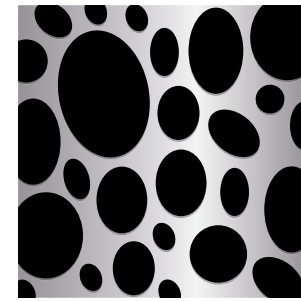

Austin

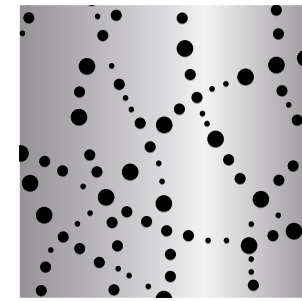

Bubble Trail

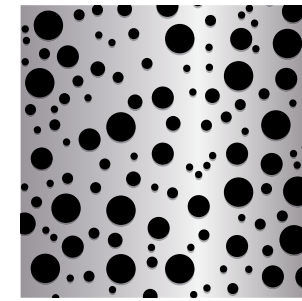

Bubbles

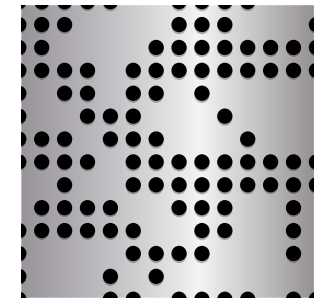

Digital

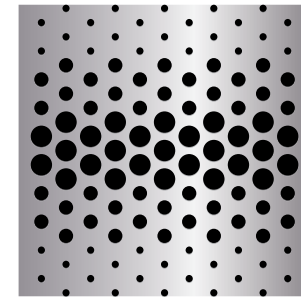

Horizon

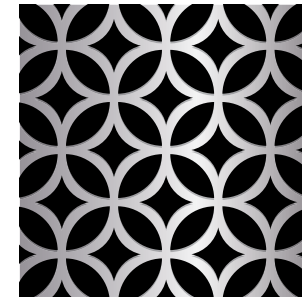

Lotus

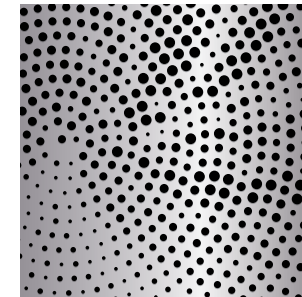

Spiral

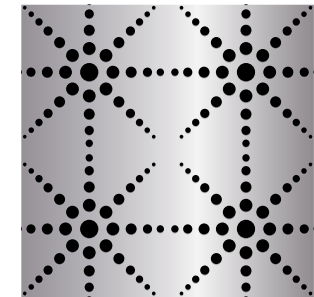

Starburst

Laser Patterns

Hendrick's newest 8kW fiber laser removes several obstacles for precise custom designs when cutting metal.

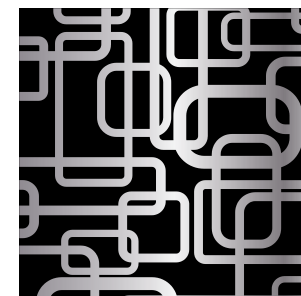

Maze

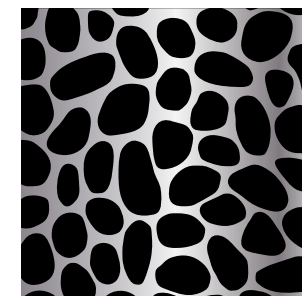

River Stone

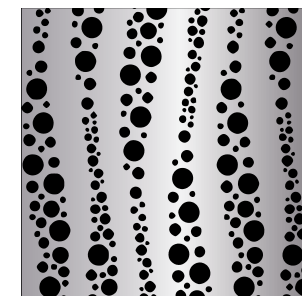

Seaweed

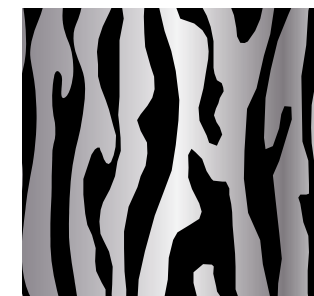

Tree Bark

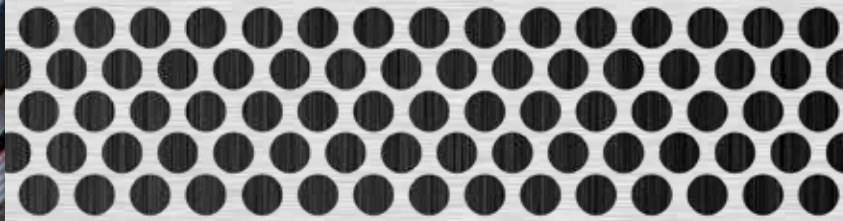

Get Air

Pomona, CA

Wheeler & Wheeler Architects

perforated corrugated panels

BWR360 profile

.125" dia. holes | 30% open area

aluminum

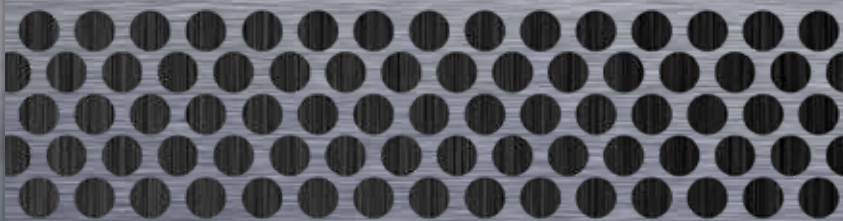

Perforated Corrugated Profiles

Nine standard profiles are offered, as well as custom options to fit any project's design intent. The panels are available in a selection of aluminum thicknesses, panel profiles, and colors.

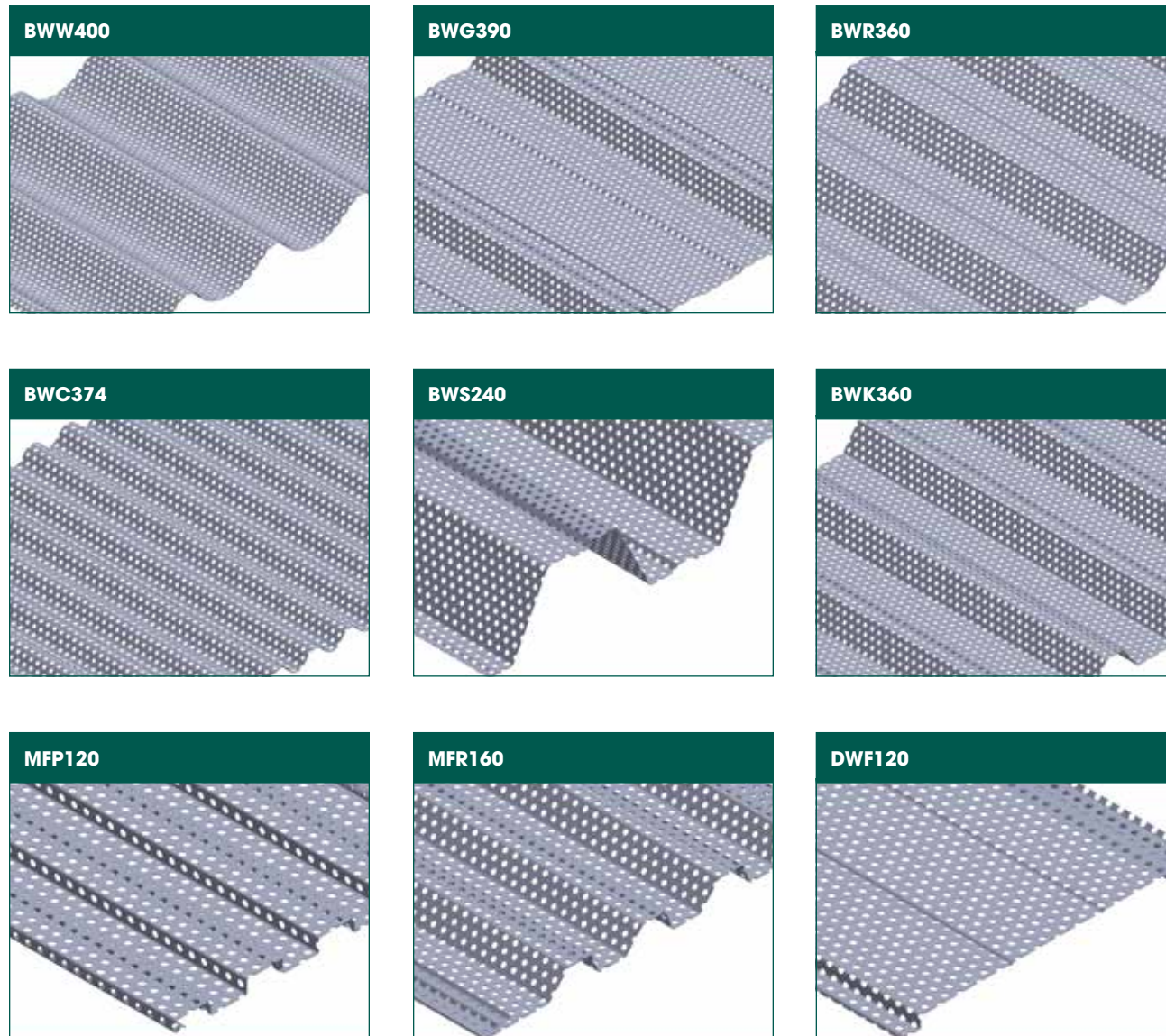

Open Area Percentages for Standard 60° Staggered Hole Patterns by Profile

	BWC374	BWG390	BWK360	BWR360	BWW400	DWF120	MFP120	MFR160	BWS240
.125" on .188"	47.4	45.5	49.2	46.3	46.6	47.8	54.7	57.1	56.4
.125" on .218"	35.3	33.9	36.6	34.5	34.7	35.6	40.7	42.5	41.9
.125" on .250"	26.8	25.8	27.8	26.2	26.4	27.1	30.9	32.3	31.9
.125" on .375"	11.9	11.5	12.4	11.7	11.7	12.0	13.8	14.4	14.2
.188" on .313"	38.7	37.2	40.1	37.8	38.1	39.0	44.7	46.6	46.0
.250" on .500"	26.8	25.8	27.8	26.2	26.4	27.0	30.9	32.3	31.9
.375" on .500"	60.3	57.9	62.6	59.0	59.3	60.9	69.6	72.6	71.7
.375" on .563"	47.6	45.7	49.4	46.5	46.8	48.0	54.9	57.3	56.6

Aluminum Options

	BWC374	BWG390	BWK360	BWR360	BWW400	DWF120	MFP120	MFR160	BWS240
.032"	✓	✓	✓	✓	✓	✓	✓	✓	✓
.040"	✓	✓	✓	✓	✓	✓	✓	✓	✓
.050"	✓		✓	✓	✓	✓	✓	✓	✓

- ✓ Over 30 standard colors
- ✓ Color matched trim
- ✓ Color matched fasteners

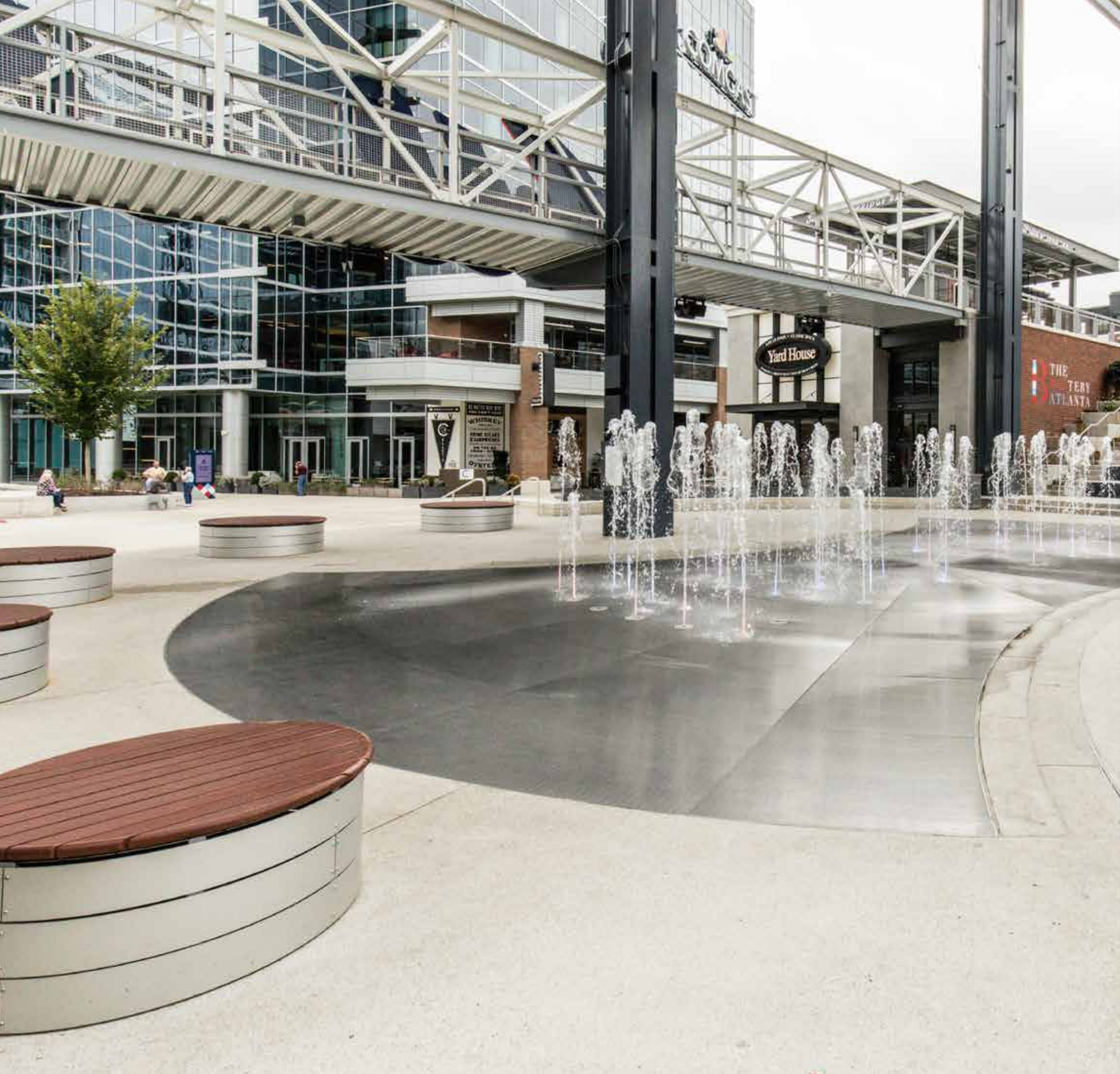

SunTrust Park

Atlanta, GA

HGOR & Aqua Underground

*curved Profile Bar grating
B12 bars | .188" bar opening
stainless steel*



Gateway Arch Museum

St. Louis, MO

*Cooper Robertson & James Carpenter
Design Associates*

Profile Bar entrance grilles
B12 bars | .125" bar opening
stainless steel

Profile Bar wall panels
T24 bars | .125" bar opening
stainless steel

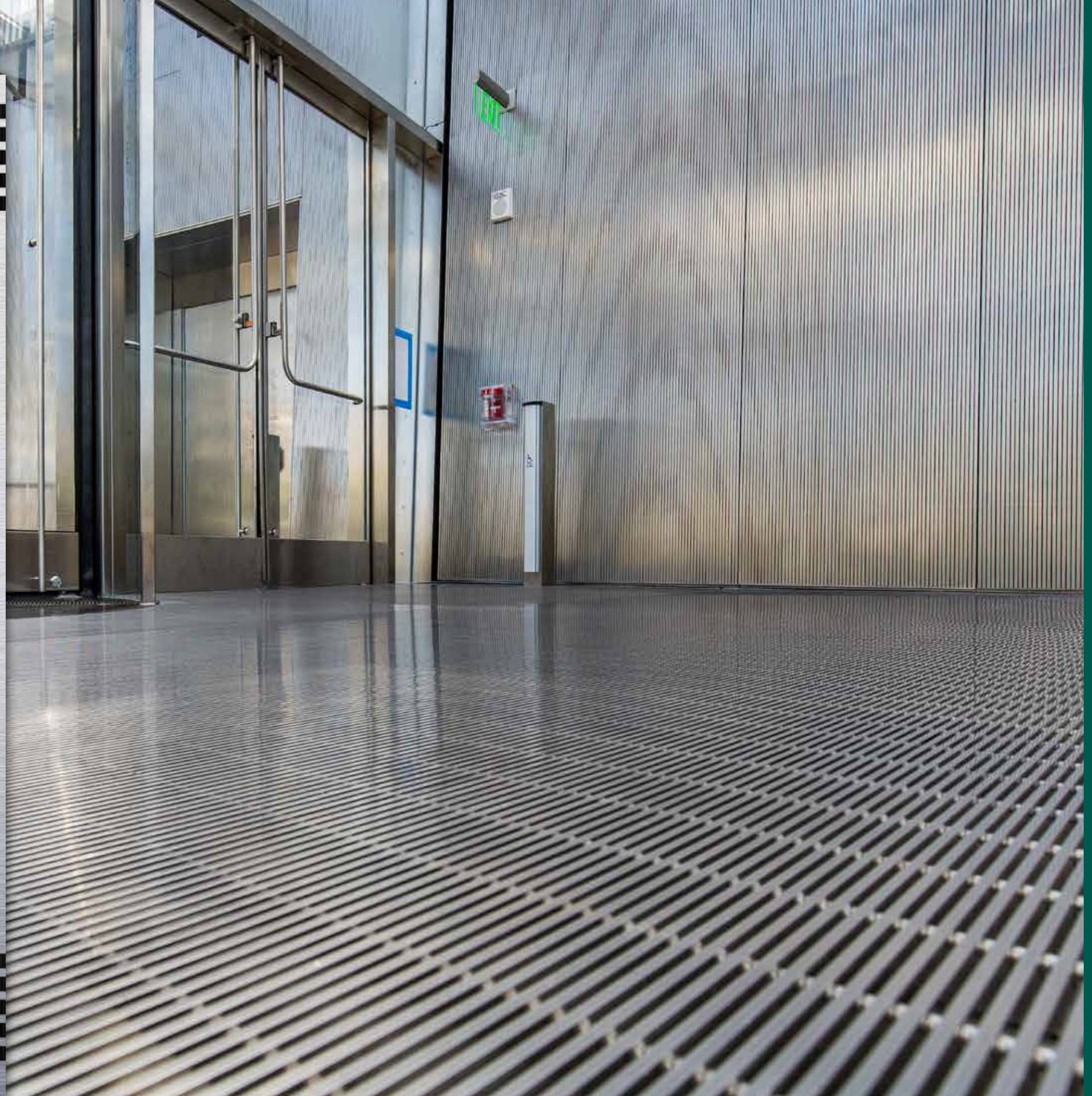



Buckhead

Atlanta, GA

Hoerr Schaudt

14' dia. Profile Bar tree grating
B9 bars | .188" bar opening
stainless steel



Holmberg Pedestrian Bridge

Chattanooga, TN

Ross Glass & Aluminum

Profile Bar grating with slip resistant coating
T16 bars | .188" bar opening
stainless steel



PROFILE BAR BRIDGE

Profile Bar

Hendrick's Profile Bar  is manufactured using a mechanically interlocked and proprietary method of construction, making it one of the strongest systems available on the market. It's perfect for applications that require high strength or a very flat surface.

- ✓ Corrosion Resistant
- ✓ Design Flexibility
- ✓ Strength
- ✓ Interlocked Construction (non-welded)

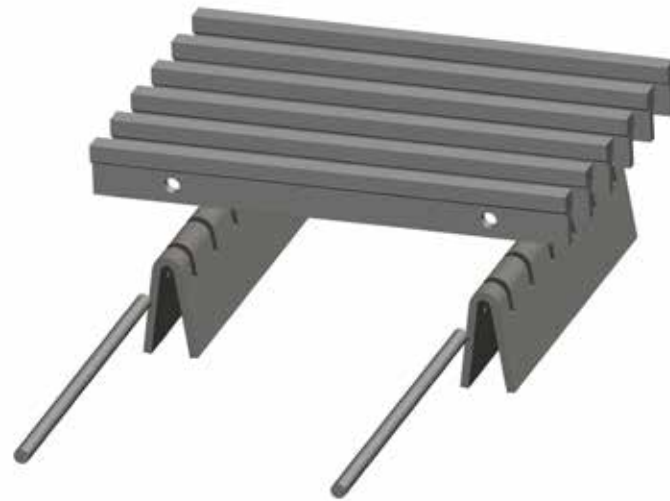

	B69	B6S	B6	B9	B12S	B12	B16	T9M	T9	F12	T12	T16	T24
Ceiling Panels	✓	✓	✓	✓	✓	✓	✓	✓	✓	✓	✓	✓	✓
Column Covers	✓	✓	✓	✓	✓	✓	✓	✓	✓	✓	✓	✓	✓
Entrance Grilles	✓			✓	✓	✓	✓	✓	✓	✓	✓	✓	✓
Tree Grating	✓			✓		✓	✓		✓	✓	✓	✓	✓
Wall Cladding	✓	✓	✓	✓	✓	✓	✓	✓	✓	✓	✓	✓	✓
Ventilation Grilles	✓	✓	✓	✓	✓	✓	✓	✓	✓	✓	✓	✓	✓
Custom Applications	✓	✓	✓	✓	✓	✓	✓	✓	✓	✓	✓	✓	✓

Material Options:	B69	B6S	B6	B9	B12S	B12	B16	T9M	T9	F12	T12	T16	T24
Aluminum				✓		✓						✓	
Stainless Steel	✓	✓	✓	✓	✓	✓	✓	✓	✓	✓	✓	✓	✓

Wedge Wire

Hendrick's resistance welded wedge wire, also known as profile wire or v-wire, is manufactured by wrapping wire helically around supports that are resistance welded together. It can be fabricated to a variety of shapes, sizes, and open areas. The result is a very strong product with a smooth surface that is resistant to clogging. This makes wedge wire advantageous for corrosion resistance and ADA compliant applications.



	69V	90V	125V
Ceiling Panels	✓	✓	✓
Column Covers	✓	✓	✓
Entrance Grilles	✓	✓	✓
Tree Grating	✓	✓	✓
Wall Cladding	✓	✓	✓
Ventilation Grilles	✓	✓	✓
Custom Applications	✓	✓	✓

Material Options:	69V	90V	125V
Stainless Steel	✓	✓	✓

Profile Bar with Carpet Insert

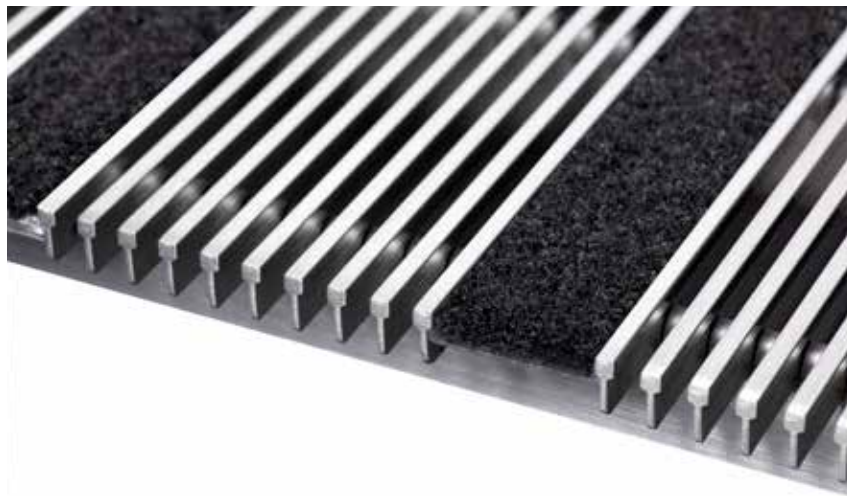

Carpet Insert Width = 1"
 Recommended 4" max
 spacing between inserts
 Inserts designed to be
 slid into place

Profile Bar with Anti-Slip Coating



A. 1" wide coated bars with
 recommended 4" max
 spacing



B. 1/2" wide coated bars
 with recommended
 4" max spacing



C. Coated on alternating
 profile bars

D. Coated on 100% of grille's top surface (not pictured)

Other Finishes

- #4 Satin
- ALGRIP (Profile Bar only)
- Anodized Profile Bar only)
- Bead-blasted
- Matte (non-directional)
- Painted
- Powder-coated
- Sandblasted

Mounting Options

EZ Loc Mounting System

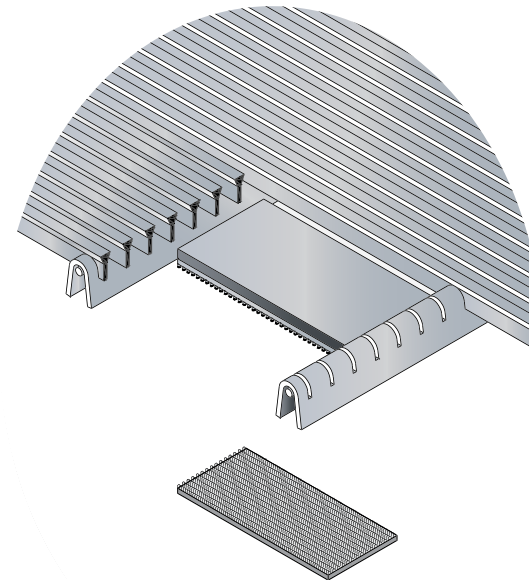

Hidden Mounting Tab System

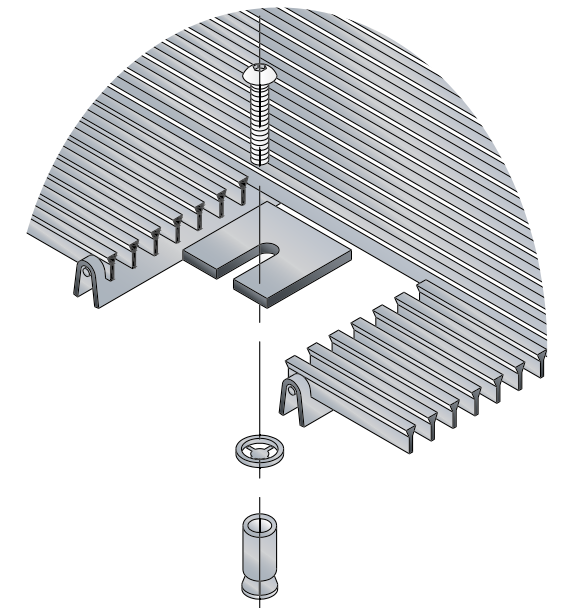

Surface Block Mounting System

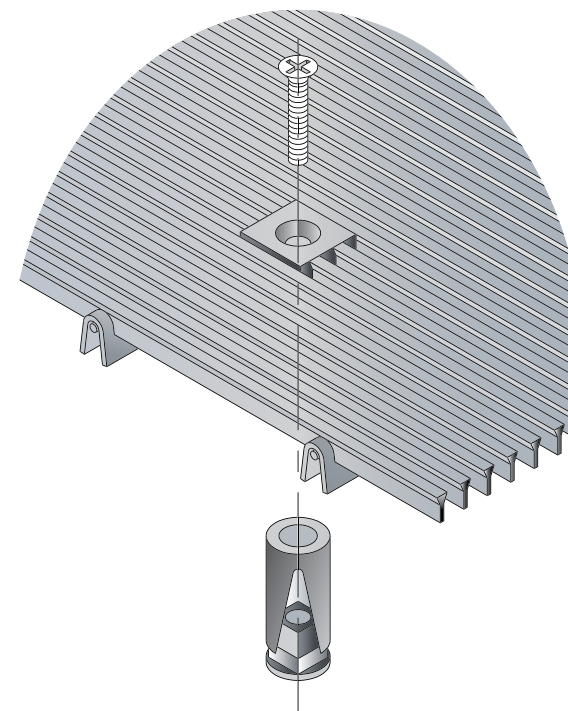

Hidden Hold-Down Clip System

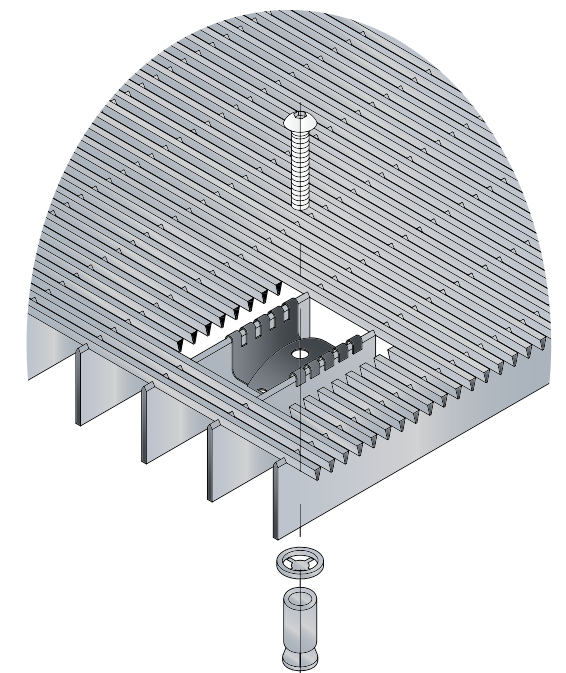

*Option for Wedge Wire Only

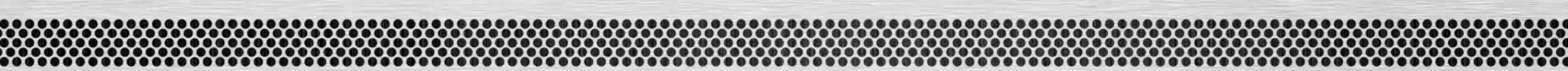

Stair Components

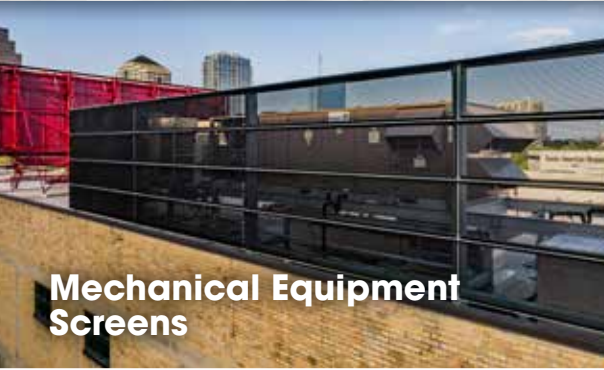

Mechanical Equipment Screens



Ceiling Panels



Ventilation Grilles



Guardrails



Signage

ADDITIONAL APPLICATIONS



*University Hospitals Case
Medical Center*

Cleveland, OH

Array Architects

perforated cladding
.250" dia. holes | 23% open area
aluminum

CUTTING EDGE METAL SOLUTIONS

Hendrick

ARCHITECTURAL

1 Seventh Ave.
Carbondale, PA 18407

3074 Medley Rd.
Owensboro, KY 42301

To request samples, view project pictures & videos, or for technical information, please visit www.hendrickarch.com or call 877-840-0881.

